

Diffuse mode sensor

GLV18-8-200/115/120



- Efficient Line in a short M18 plastic housing for standard applications
- 4 LEDs indicator for 360° visibility
- Optimized potentiometer design for a clear control button layout in the application
- Version with front optical face
- DC voltage version

Diffuse mode sensor, M18 threaded housing design, plastic housing, front optical face, 200 mm detection range, red light, light/dark on, DC version, 2 PNP outputs, fixed cable



Function

The GLV/GLK18 series sensors help improve the efficiency of machines and systems. The design of the M18 plastic housing, the connection technology, and sensor properties are highly standardized. Concentrating on the key sensor requirements has produced a robust and reliable product series for DC and AC/DC voltage systems without any over-engineering. The mounting set included in the scope of delivery and the optimized potentiometer design ensure fast assembly and easy configuration.

Dimensions

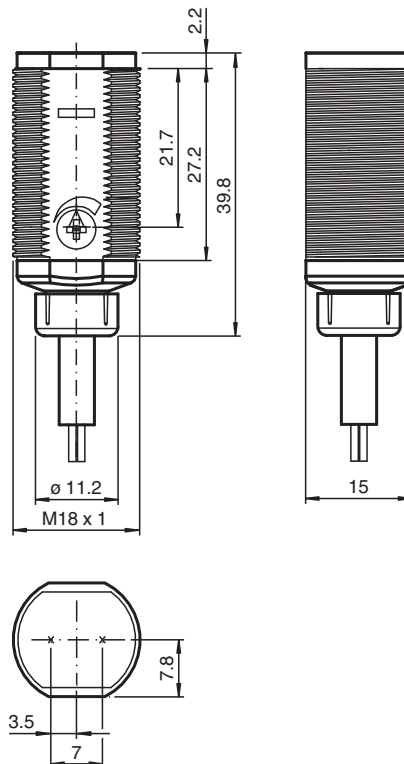

Release date: 2020-11-06 Date of issue: 2020-11-06 Filename: 188574_eng.pdf

Refer to "General Notes Relating to Pepperl+Fuchs Product Information".

Pepperl+Fuchs Group
www.pepperl-fuchs.com

USA: +1 330 486 0001
fa-info@us.pepperl-fuchs.com

Germany: +49 621 776 1111
fa-info@de.pepperl-fuchs.com

Singapore: +65 6779 9091
fa-info@sg.pepperl-fuchs.com

pepperl+fuchs

Technical Data

General specifications		
Detection range		50 ... 200 mm adjustable
Detection range max.		0 ... 200 mm
Reference target		100 mm x 100 mm Kodak white
Light source		LED
Light type		modulated visible red light , 640 nm
Diameter of the light spot		approx. 15 mm at 200 mm
Angle of divergence		approx. 4 °
Optical face		frontal
Ambient light limit		30000 Lux
Hysteresis	H	< 15 %
Functional safety related parameters		
MTTF _d		920 a
Mission Time (T _M)		20 a
Diagnostic Coverage (DC)		0 %
Indicators/operating means		
Operation indicator		LED green, statically lit Power on
Function indicator		LED yellow: lights when object is detected ; flashes when falling short of the stability control
Control elements		sensitivity adjustment
Electrical specifications		
Operating voltage	U _B	10 ... 30 V DC
No-load supply current	I ₀	< 20 mA
Output		
Switching type		light/dark on
Signal output		2 PNP, complementary, short-circuit protected, open collectors
Switching voltage		max. 30 V DC
Switching current		max. 100 mA
Voltage drop	U _d	≤ 1.5 V DC
Switching frequency	f	500 Hz
Response time		≤ 1 ms
Conformity		
Product standard		EN 60947-5-2
Approvals and certificates		
Protection class		II, Rated insulation voltage ≤ 50 V AC with pollution degree 1-2 according to IEC 60664-1
UL approval		cULus Listed, Class 2 Power Source
CCC approval		CCC approval / marking not required for products rated ≤36 V
Ambient conditions		
Ambient temperature		-25 ... 60 °C (-13 ... 140 °F)
Storage temperature		-40 ... 70 °C (-40 ... 158 °F)
Mechanical specifications		
Degree of protection		IP67
Connection		2 m fixed cable
Material		
Housing		PC
Optical face		PMMA
Cable		PVC
Mass		approx. 75 g

Connection Assignment

Option:

/120

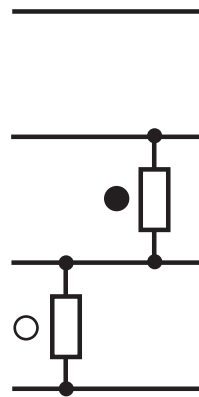
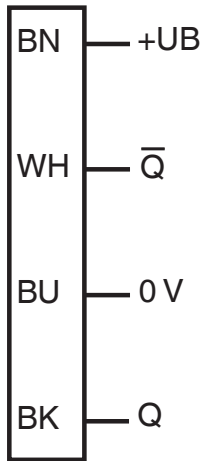

○ = Light on
● = Dark on

Assembly

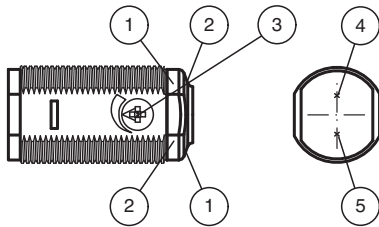

1	Operating display	green
2	Signal display	yellow
3	Sensitivity adjustment	
4	Emitter	
5	Receiver	

Characteristic Curve

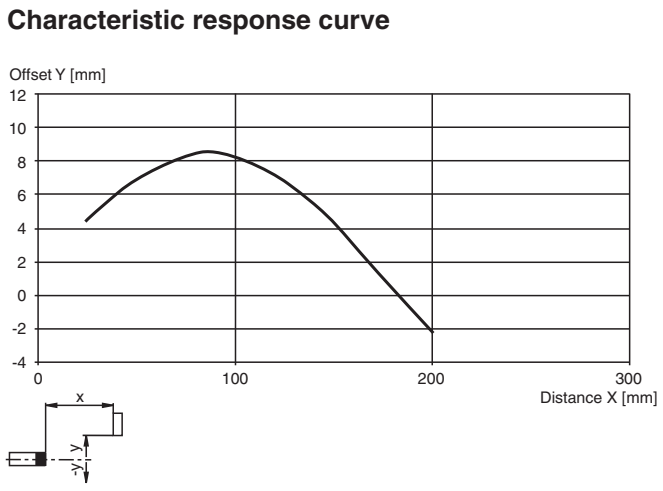

Release date: 2020-11-06 Date of issue: 2020-11-06 Filename: 188574_eng.pdf

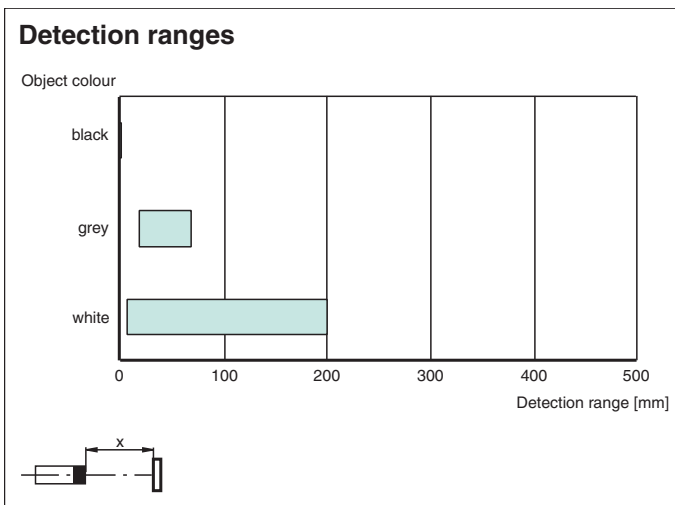
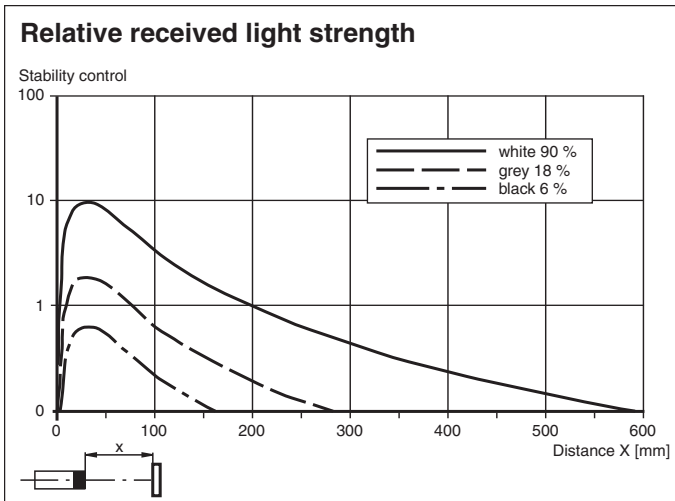



Application



Release date: 2020-11-06 Date of issue: 2020-11-06 Filename: 188574_eng.pdf

Accessories

	CPZ18B03	Mounting Bracket with swivel nut
	BF 18	Mounting flange, 18 mm
	BF 18-F	Plastic mounting adapter, 18 mm

Refer to "General Notes Relating to Pepperl+Fuchs Product Information".

Accessories



BF 5-30

Universal mounting bracket for cylindrical sensors with a diameter of 5 ... 30 mm

Release date: 2020-11-06 Date of issue: 2020-11-06 Filename: 188574_eng.pdf

Refer to "General Notes Relating to Pepperl+Fuchs Product Information".

Pepperl+Fuchs Group
www.pepperl-fuchs.com

USA: +1 330 486 0001
fa-info@us.pepperl-fuchs.com

Germany: +49 621 776 1111
fa-info@de.pepperl-fuchs.com

Singapore: +65 6779 9091
fa-info@sg.pepperl-fuchs.com

 **PEPPERL+FUCHS**

Accessories

Other suitable accessories can be found at www.pepperl-fuchs.com

Application

Packaging industry:

- Presence checks, track loading, completeness checks, stack height control

Material handling

- Presence checks, target sensor, profile checks, trigger sensor

Automatic doors, gates and access systems, elevator:

- Secure detection for automatic door and gate systems
- Monitoring function in turnstiles
- Closing edge monitoring in elevators